

EBONY

SIMPLICITY
ON DISPLAY





Ebony, a refrigerated counter conceived with essential design enhancing the goods displayed.

Its clean design makes products highly visible as its plain surfaces reduce light reflections and refractions to a minimum.

IT

Ebony è il banco refrigerato che mette l'essenzialità del design al servizio di un'alta visibilità.

Un design pulito e semplice, fatto di superfici piane che riducono al minimo riflessi e rifrazione, per dare il giusto risalto ai prodotti esposti.



The Power of Simplicity

Tutti gli angoli di cui hai bisogno.

Ebony è estremamente versatile e personalizzabile: è possibile realizzarlo con angoli sferici di 90°, 45° o 22.5°, aperti o chiusi, e con angoli a spigolo di qualunque gradazione, a seconda delle esigenze.

EN

All the corners you need.

Ebony is extremely versatile and customisable: it can be made with round corners (90°, 45° or 22.5°), open or closed, and with angled corners of any gradation, as required.

FR

Tous les angles dont vous avez besoin.

Ebony est extrêmement universel et personnalisable: il est possible de le réaliser avec des angles sphériques de 90°, 45° ou 22.5°, ouverts ou fermés, ainsi qu'avec des angles vifs de n'importe quel degré, en fonction des exigences spécifiques.

DE

Alle Ecken, die Sie brauchen.

Ebenholz ist äußerst vielseitig und anpassbar: Es ist möglich, es mit sphärischen Winkeln von 90°, 45° oder 22,5°, offen oder geschlossen, und mit Eckwinkeln von jedem Grad zu erstellen, je nach Bedarf.



1

Vetro anteriore apribile verso l'alto con pistoni.

EN Front glass that opens upwards with pistons.

FR Vitre frontale ouvrable vers le haut avec pistons.

DE Nach oben öffnendes Frontglas (mit Kolben).

2

Illuminazione CRIOLED®.

EN CRIOLED® lighting.

FR Eclairage CRIOLED®.

DE CRIOLED®-Beleuchtung.

3

Zona esposizione e interno del mobile in acciaio inox.

EN Inside area and display surface in stainless steel.

FR Zone d'exposition et intérieur du meuble en acier inoxydable.

DE Ausstellungsfläche und Schrankinnenseite aus Edelstahl.

4

Vasca senza componenti frigoriferi per garantire la massima pulizia.

EN Tank without refrigerating installations for the utmost cleanliness.

FR Bac sans composants frigorifiques afin de garantir une propreté maximale.

DE Wanne ohne kältetechnische Komponenten für maximale Sauberkeit.

5 Zoccolo parapolvere su tutto il perimetro del banco.
EN Bumper skirting
FR Plinthe antipoussière sur tout le périmètre du comptoir.
DE Staubdichter Sockel um den gesamten Umfang der Theke.

6 Refrigerazione ventilata con evaporatore trattato in cataforesi anticorrosione.
EN Ventilated refrigeration with evaporator featuring anticorrosion treatment (electrophoretically coated)
FR Réfrigération ventilée avec évaporateur traité par cataphorèse anticorrosion.
DE Belüftete Kühlung mit korrosionsgeschütztem Kataphorese-Verdampfer.

7 Pannello frontale personalizzabile - vedi tabella colori.
EN Customisable front panel - see colour chart.
FR Panneau frontal personnalisable - voir nuancier couleurs.
DE Individuell gestaltbare Frontplatte - siehe Farbkarte.

8 Canalizzabile.
EN Multiplexable.
FR Canalisable.
DE Kanalisierung möglich.

9 Cornice frontale in alluminio lucido (optional).
EN Polished aluminium front frame (optional).
FR Encadrement frontal en aluminium brillant (option).
DE Frontrahmen aus poliertem Aluminium (optional).

10 Ventilazione frontale antiappannante
EN Anti-fog front ventilation.
FR Ventilation frontale anti-buée.
DE Antibeschlag-Belüftung an der Vorderseite.





Essential Design, High Visibility

EBONY	L (cm)*	62,5	93,7	125	187,5	218,8	250	281,2	312,5	375
Consumo orario / Hourly consumption	Wh	60	65	70	130	132,5	140	142,5	200	210
Fabbisogno frigorifero Ø 24-deft / Cooling requirement Ø 24-deft	W	225	337	450	562	675	786	900	1012	1125
Classe climatica / Climate Class	ISO 23953-2	3 - M1								
Superficie espositiva / Display surface	m²	0,56	0,84	1,13	1,69	1,69	1,96	2,25	2,53	2,81
Portata piani esposizione / Maximum load display surface	Kg/m - Kg/m²	95 - 105 (l)								
Controllo - banco senza gruppo frigorifero Control - cabinet without built-in refrigerator unit	ELECTRONIC	WOW Touch Control								

EBONY H-COMBI	L (cm)*	62,5	93,7	125	156,2	187,5				
Consumo orario / Hourly consumption	Wh	1884	2064	3186	3576	5358				
Resistenze riscaldamento ventilato / Ventilated electrical heater	W	1500	1500	3000	3000	4500				
Resistenza per umidità controllata Electrical heater for controlled humidity	W	800	800	800	800	1600				
Controllo / Control	ELECTRONIC	WOW Touch Control								

EBONY S-CONCEPT	L (cm)*	62,5	93,7	125	187,5	218,8	250	281,2	312,5	375
Consumo orario / Hourly consumption	Wh	25	32,5	40	65	69	80	84	135	150
Fabbisogno frigorifero Ø 24-deft / Cooling requirement Ø 24-deft	W	238	356	475	713	829	950	1069	1188	1425
Classe climatica / Climate Class	ISO 23953-2	3 - M2								
Superficie espositiva / Display surface	m²	0,51	0,77	1,03	1,54	1,79	2,05	2,31	2,56	3,08
Portata piani esposizione / Maximum load display surface	Kg/m - Kg/m²	95 - 105 (l)								
Controllo - banco senza gruppo frigorifero Control - cabinet without built-in refrigerator unit	ELECTRONIC	WOW Touch Control								

EBONY G-CONCEPT	L (cm)*	125	187,5	218,8	250	281,2	312,5	375		
Consumo orario / Hourly consumption	Wh	140	160	162,5	180	182,5	200	220		
Fabbisogno frigorifero Ø 24-deft / Cooling requirement Ø 24-deft	W	475	713	829	950	1069	1188	1425		
Classe climatica / Climate Class	ISO 23953-2	3 - M1								
Superficie espositiva / Display surface	m²	1,03	1,54	1,79	2,05	2,31	2,56	3,08		
Portata piani esposizione / Maximum load display surface	Kg/m - Kg/m²	95 - 105 (l)								
Controllo - banco senza gruppo frigorifero Control - cabinet without built-in refrigerator unit	ELECTRONIC	WOW Touch Control								

IL MAGNIFICO TOWER	L (cm)*	93,7	125	156,2	187,5					
Consumo orario / Hourly consumption	Wh	434	579	723	868					
Fabbisogno frigorifero Ø 24-deft / Cooling requirement Ø 24-deft	W	565	753	941	1130					
Classe climatica / Climate Class	ISO 23953-2	3 - M1								
Superficie espositiva / Display surface	m²	1,69	2,25	2,82	3,38					
Portata piani esposizione / Maximum load display surface	Kg/m - Kg/m²	95 - 105 (l)								
Controllo - banco senza gruppo frigorifero Control - cabinet without built-in refrigerator unit	ELECTRONIC	WOW Touch Control								

L (cm)*= Lunghezza senza spalle. Spessore 1 spalla: 4 cm.
L (cm)*= Length without endwalls. Thickness 1 endwall: 4 cm.

(l) Carico Uniformemente distribuito
(l) Uniformly distributed load

Le caratteristiche tecniche potranno subire modifiche senza preavviso.
EN Technical details could be changed without notice.
FR Les caractéristiques techniques pourraient subir des modifications sans préavis.
DE Änderungen vorbehalten.

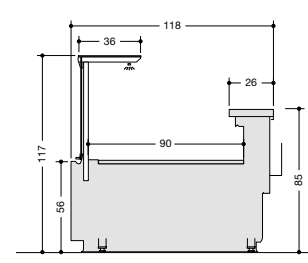

EBONY A

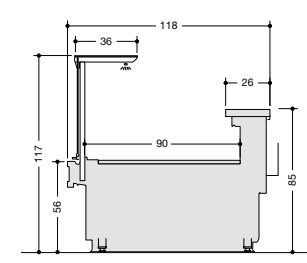

EBONY D

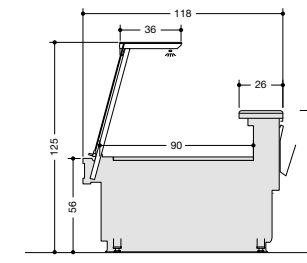

EBONY K

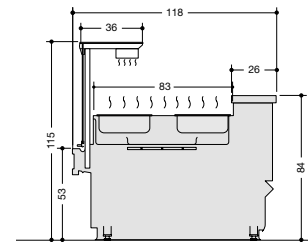

EBONY H-COMBI

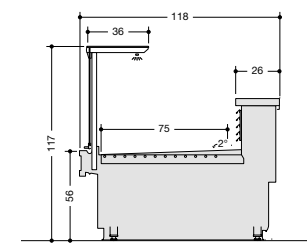

EBONY S-CONCEPT

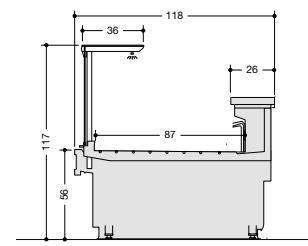

EBONY G-CONCEPT

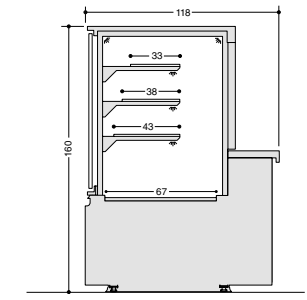

IL MAGNIFICO TOWER

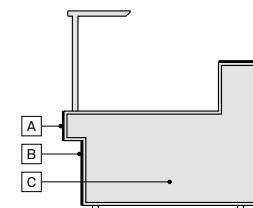

A	B	C
D90	D90	D90
D91	D91	D91
D96	D96	D96
D97	D97	D97
D136	D136	D136
D137	D137	D137
D138	D138	D138
D151*	D151*	D151*
RAL*	RAL*	RAL*
P36*	P36*	P36*
P61*	P61*	P61*
P63*	P63*	P63*
P67*	P67*	P67*
P70*	P70*	P70*
P73*	P73*	P73*
P81*	P81*	P81*
P82*	P82*	P82*
P83*	P83*	P83*
P84*	P84*	P84*
P85*	P85*	P85*
P86*	P86*	P86*
I301*	I301*	I301*
I303*	I303*	I303*

*= Colore con sovrapprezzo
*= Color at Extra cost
*= Supplément couleur
*= Farb mit Aufpreis



EBONY

SIMPLICITY ON DISPLAY

CRIDCABIN
TASTE PRESENTATION



GKM Gewerbekühlmöbel AG
Türlacherweg 40
6060 Sarnen

info@gkm-ag.ch
gkm-ag.ch